

THESE DRAWINGS ARE THE PROPERTY OF QUALTEK ELECTRONICS AND NOT TO BE REPRODUCED FOR OR COMMUNICATED TO A THIRD PARTY WITHOUT THE EXPRESS WRITTEN PERMISSION OF AN OFFICER OF QUALTEK ELECTRONICS.

REVISION			
REV.	DESCRIPTION	DATE	APPROVED

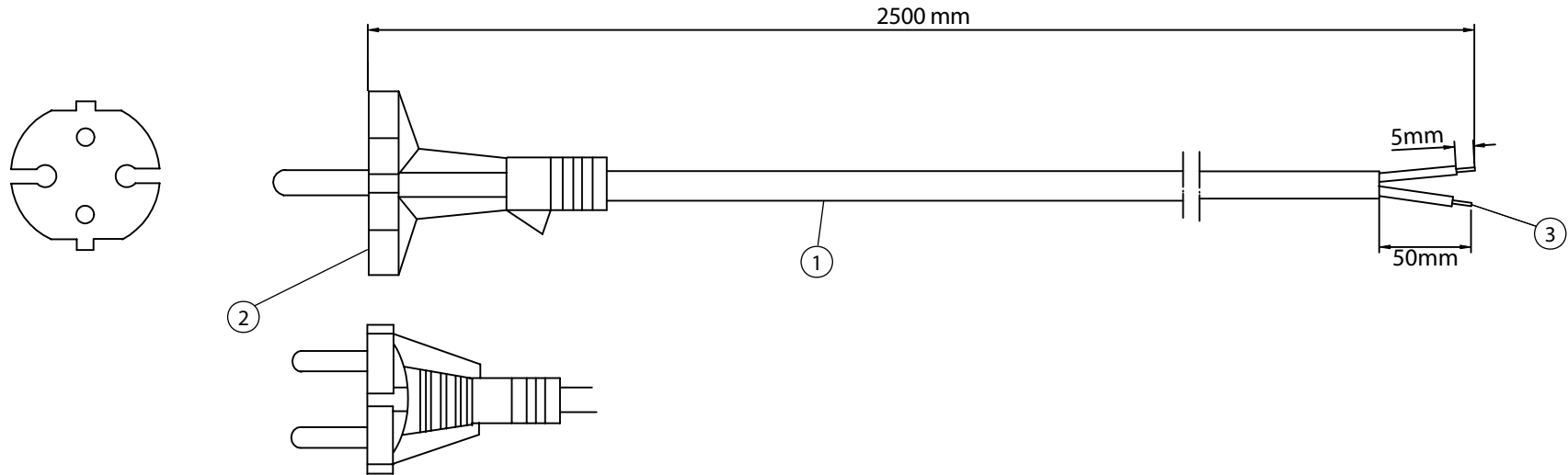

**CONTROLLED**

NOTES:

1. CORDAGE: H05VV-F, 2x0.75mm, UNSHIELDED, CEE COLOR CODE, TEMP. RATING 70°C, RATING: 250V 6A, JACKET COLOR: BLACK
2. PLUG: CONTINENTAL EUROPE
3. OTHER END: ROJ 50mm STRIP 5mm
4. APPROVALS: GERMANY, SWITZERLAND, DENMARK, NORWAY, FINLAND, FRANCE, BELGIUM, ITALY, NETHERLANDS, SWEDEN, AUSTRIA
5. ROHS COMPLIANT

Dim range (mm)	Tolerance +/- (mm)	Qualtek Electronics Corp. PPC DIVISION		
0-1	0.15	Part Number: 362004-E01		RoHS Compliant
1-6	0.20	Description: POWER CORD		
6-18	0.30		UNIT: mm	REV. B
18-50	0.50	Drawn / Date	Checked / Date	Approved / Date
50-120	0.70	R.Nuti 08-22-07	08-22-07	JJH / 08-22-07
120-250	0.90			
250-500	1.20			